

MODEL MQ2030T PEAK MARQUEE TENT

OPTIONAL FLAG POLE EXT
FOR A 3' X 5' FLAG

CAUTION: Toggle ropes must be maintained tight and even for proper tensioning of the canopy fabric. The fabric must remain taut to avoid rain ponding.

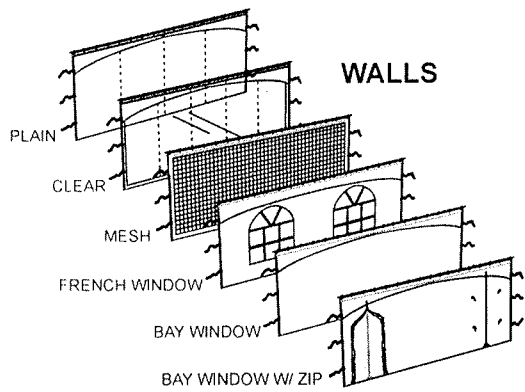
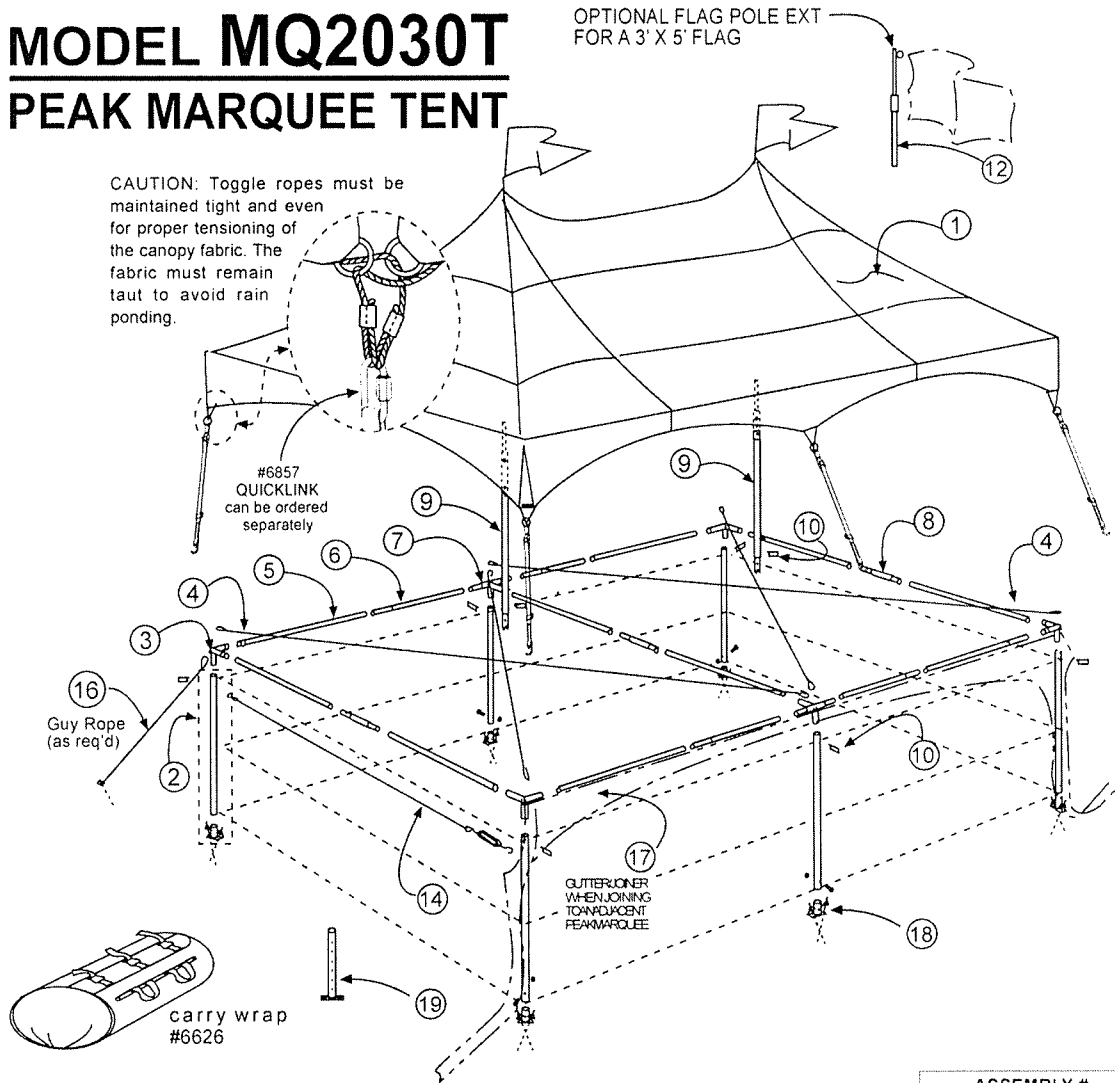

ITEM	PART	QTY	ASSEMBLY #	
			12252 ALUMINUM FRAME	12264 STEEL FRAME
(1)	TENT TOP MQ2030T	1	12253	
(2)	POST 8'	6	10591	10590
(3)	CORNER 90°	4	10628	
(4)	CROSS CABLE	4	11818	
(5)	EVE TUBE 9'3"	10	10630	7161
(6)	EVE TUBE 5'	4	10511	8444
(7)	T-PLUS	2	9465	
(8)	MID JOINT	3	10667	7284
(9)	CENTREPOLE	2	10978	
(10)	LOCK PIN	8	7843	
(18)	BASE; MQ FLAT	6	10514	
(11)	STAKE 3/4" x 34"	12	10666	
(12)	FLAG POLE EXT.	2	9523	
(13)	DROP SHEET	1	10580	
(14)	CABLE: SLIDING WALL 20'	as req'd	10673	
(14)	CABLE: SLIDING WALL 30'	as req'd	11004	
(15)	BASE; MQ FLAT ADJ.	6	11064	
(16)	GUY ROPE	6	10689	
(17)	GUTTER/JOINER 20'	as req'd	10959	
(17)	GUTTER/JOINER 30'	as req'd	11006	
(19)	BASE; MQ ADJ. 24"	6	11064	

Step 1

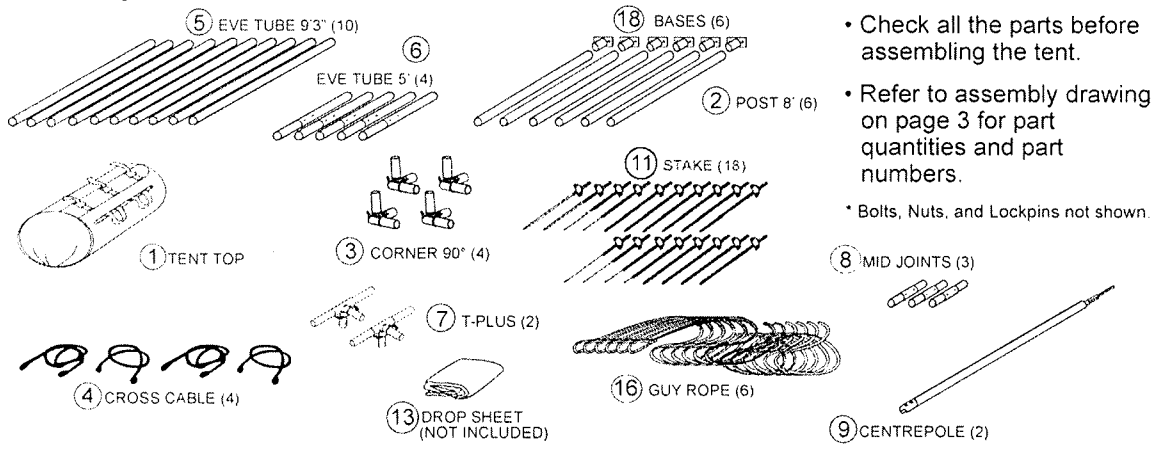

PRE ASSEMBLY

Step 2

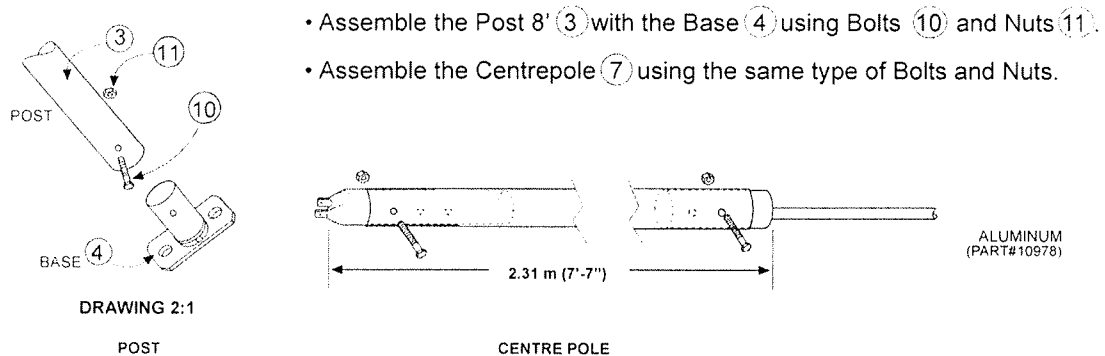

FRAME ASSEMBLY

Step 3

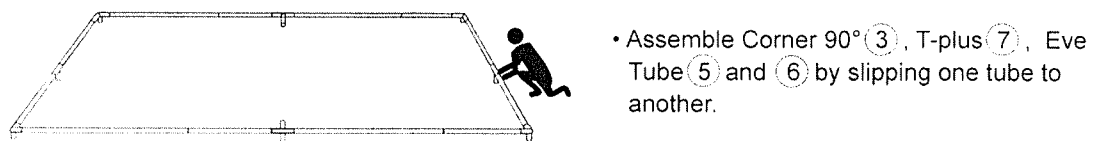

Step 4

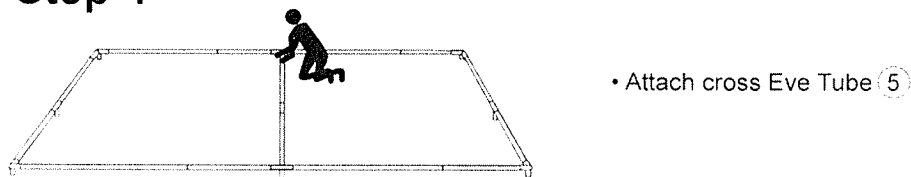

Step 5

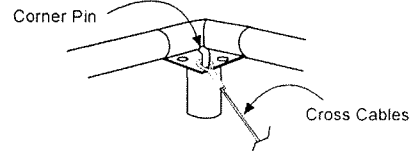
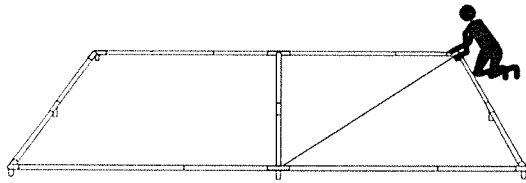

- Install first (bottom) Cross Cable ④ diagonally in square frame.
- Hook the cable end loop over the corner pin.

Step 6

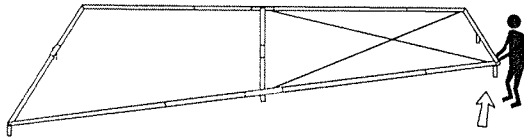

- Install second (top) Cross Cable.
- To install last loop, lift last corner to shorten the distance and hook the cable in place.
- Lowering the corner causes the corners to adjust their position and the cables to tighten.
- Repeat steps 5 and 6 for the opposite side of the tent

Step 7

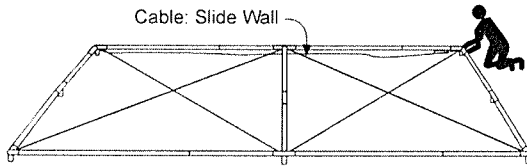

- If walls are to be installed, attach Cable for SlideWall ⑭ to the Corners and tighten turnbuckle.

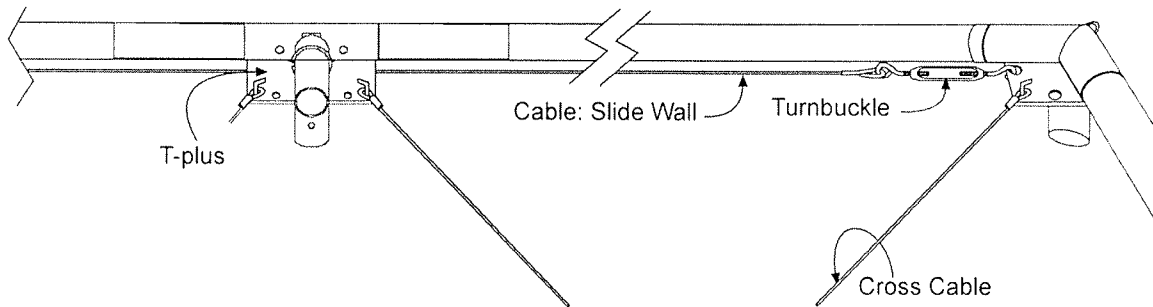

TENT TOP INSTALLATION

Step 8

PROTECTING TENT TOP

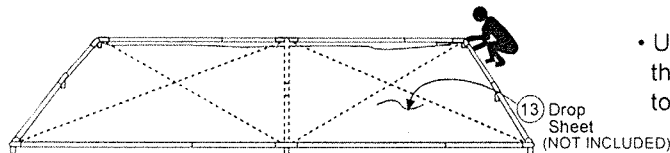

- Unfold Drop Sheet (not included) over the Cross Cables to protect the Tent Top and to keep the Tent Top clean.

ERECTING THE TENT

Step 9

UNFOLDING THE TENT TOP

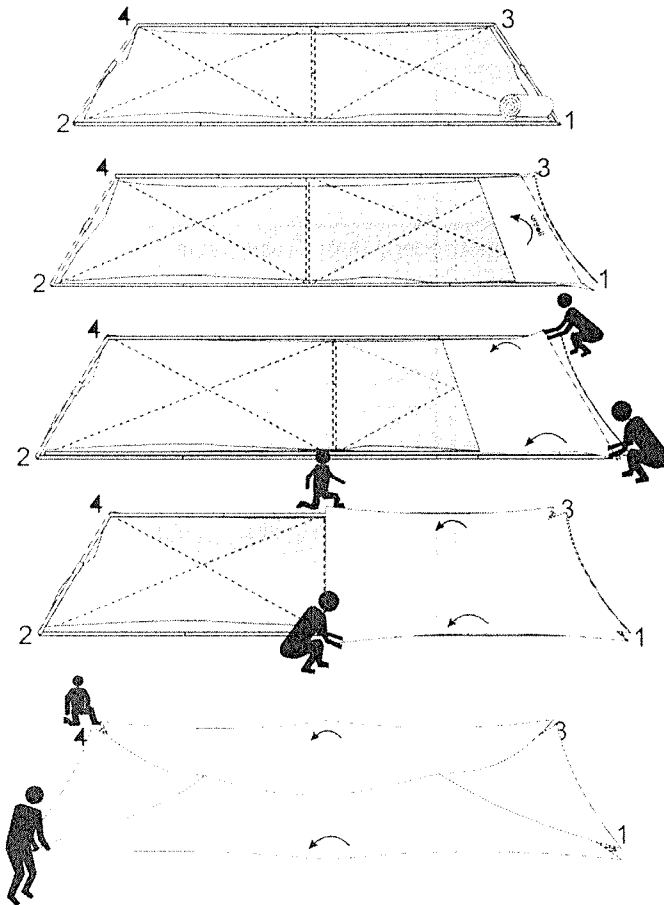

NOTE: The corners are numbered here for explanation only.

- Place the Tent Top midway along one side and unfold fabric toward the corners.
- Ensure that the valences are against the outside edge of the frame.
- Attach webbing, as shown in **Step 9A**, to corners 1 and 3.
- Pull upper layer towards the opposite end. Use toggle rope to avoid stepping on Tent Top.
- Attach webbings, as shown in **Step 9B**, to corners 2 and 4.

ATTACHING WEBBING TO CORNER LOOP

Step 9A

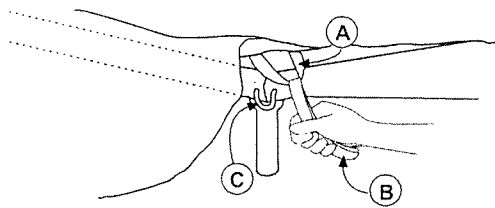

- Attach one corner of the Tent Top to the frame by pulling handle (B) to place loop webbing (A) under the corner loop (C).

Step 9B

ATTACHING THE LAST

- Attach as in 9A. If tight, insert a stake through webbing (A) and press down and under until the webbing slips under the corner loop (C).

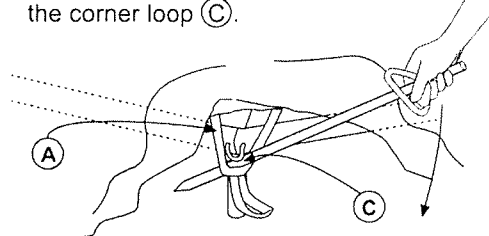

Step 10

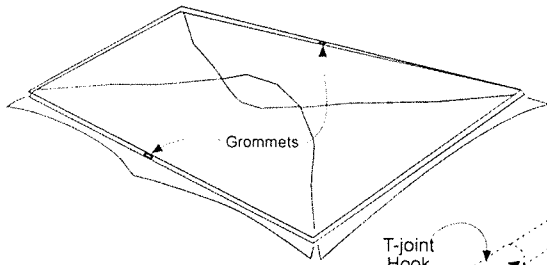

- Insert each T-Plus hook through corresponding grommet on the Tent Top.
- Temporarily hold in place with S-hook of the tension strap.

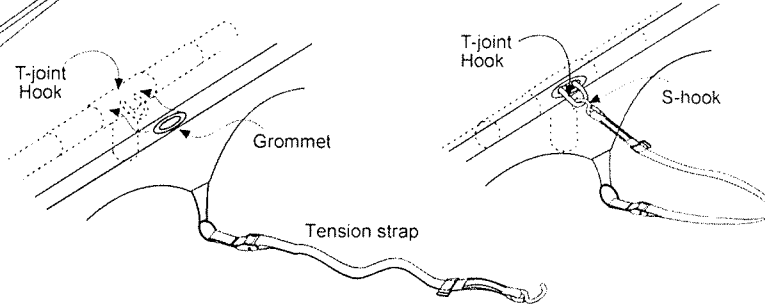

ERECTING THE TENT

Step 11

INSTALLING POSTS

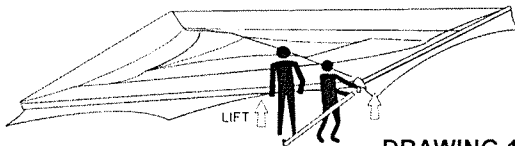

DRAWING 11:1

- To install the first Post, lift one corner and slide the Post into the Corner sleeve.
SEE DRAWING 11:1

- Lock post in place using lock-pins ↓

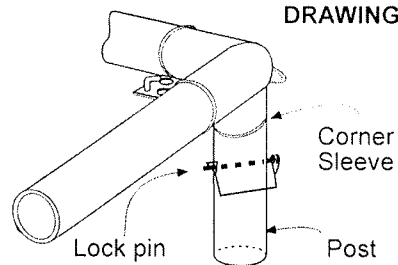

DRAWING 11:2

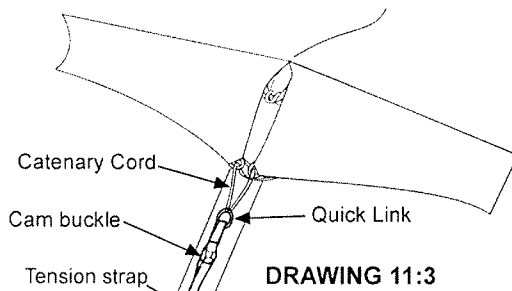

DRAWING 11:3

- Insert s-hook at the bottom of the tension strap into the hole in the Base. SEE DRAWING 11:3

- Tension strap by pulling the strap down.

- Repeating the same procedure, install 2nd corner post, followed by the side posts of the same side.

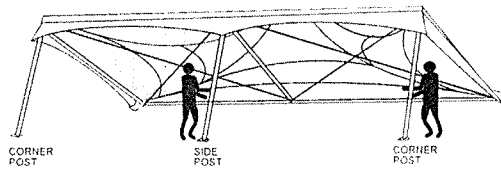
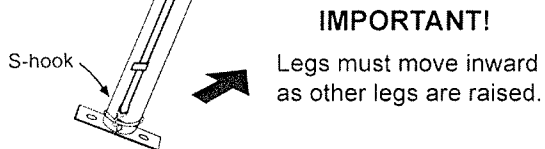

DRAWING 11:4

Step 12

CENTREPOLE INSTALLATION

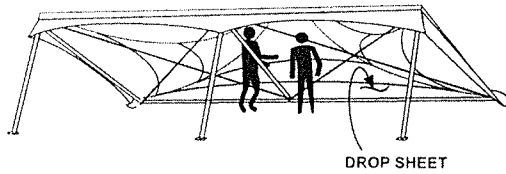

- After raising one side, move Drop Sheet towards the lower half of the frame to expose the Cable intersection.

Step 13

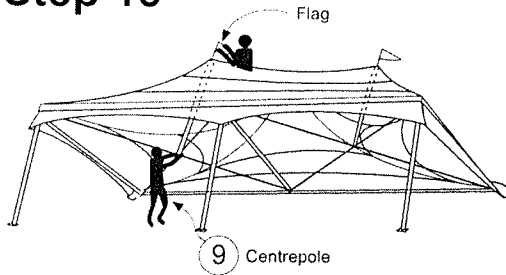

- Insert the Centrepole (9) through the centre socket of the Tent Top.
- Install the Flag on the Centrepole

* If one must step on fabric, remove shoes to avoid soiling or damaging the Tent Top.

Step 14

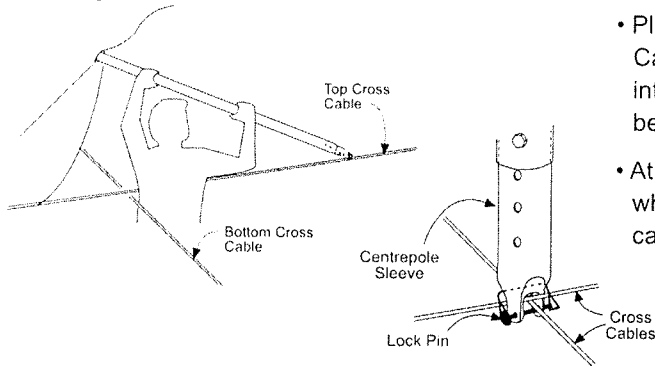

- Place the Centrepole lower end on the top Cable and slide it toward the Cross Cable intersection, wedging the Centrepole between the cover and the cables.
- At the intersection, push down bottom cable while pulling up the top cable to set both cables directly below the Centrepole sleeve.
- Secure the Centrepole to the cables using the Lock-Pin.

Step 15

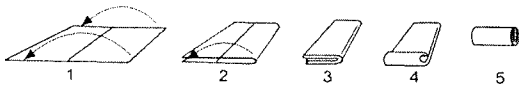

- Remove Drop Sheet and fold keeping clean side in.

Step 16

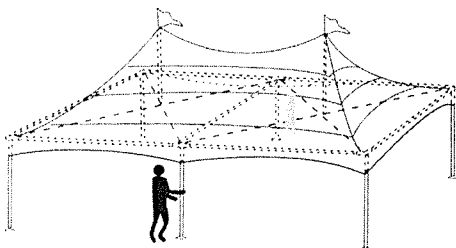

- Install the remaining Posts, inserting the Corner Posts first and then the Side Post.

- Lock Posts in place using the Lock-Pins (10).

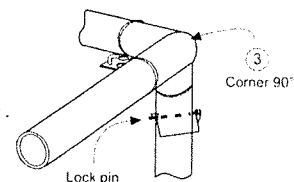

Step 17

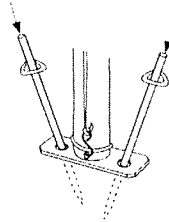
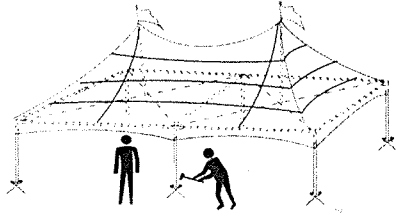

- Straighten Posts and drive Stakes (10) at each Post Base.

IMPORTANT

Each installation site must be evaluated by installer to determine proper securing method. Site conditions may require guying and anchorage different from what was provided with the tent.

Step 18 — SECURING TENSION STRAPS

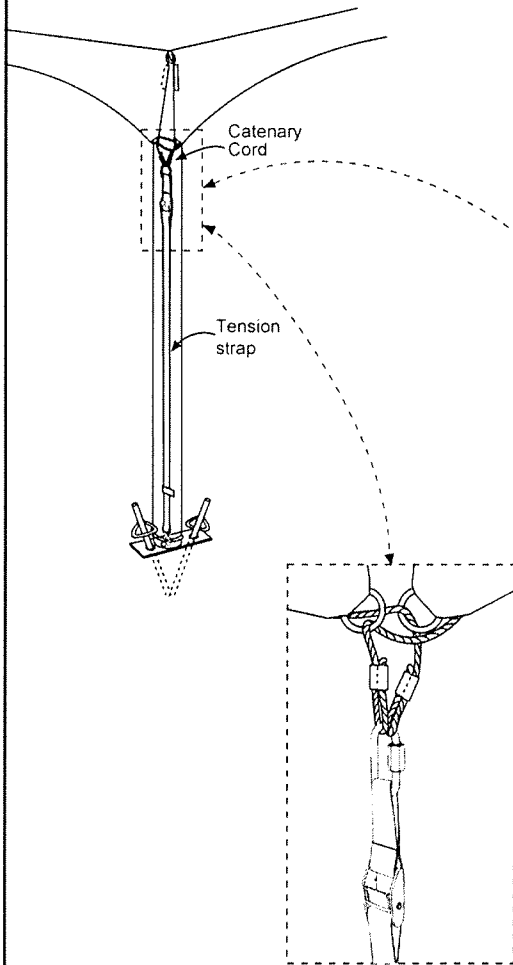

- Tension the Tent Top by tightening each tension strap. Tie off slack rope tails to main ropes.**

Catenary cord assembly detail:

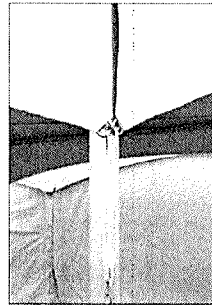

D-rings should overlap once tension strap is tensioned.

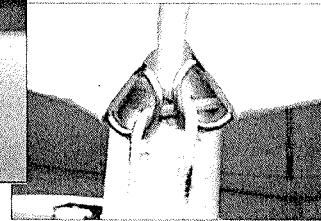

IMPORTANT: Each installation site must be evaluated by installer to determine proper securing method. Site conditions may require anchorage different from what was provided with the structure.

Summary

1. Check parts.
2. Assemble Corner 90°, 9' 3" and 5' Eve Tubes, T-plus and Midjoints to form upper frame.
3. Install Cross Cables.
4. Spread Drop Sheet over Cross Cables to protect the Tent Top.
5. Unfold Tent Top.
6. Attach Tent Top webbings to corner loops.
7. Insert T-joint hooks through grommets. Temporarily secure with S-hook.
8. Install Posts. Secure with Lock-Pin and insert the s-hook of the toggle rope into the hole in the Post Base.
9. Move Drop Sheet to clear the Cross Cable intersection area.
10. Insert Centrepole through the centre socket.
11. Install Flag from outside.
12. Slide Centrepole over the Cross Cable intersecting point.
12. Remove and fold Drop Sheet.
13. Install remaining Posts.
14. Drive Stakes through each Post Base.
15. Tension each toggle rope.
17. Install Guy Ropes, Walls, Joiners.
18. Make final inspection to ensure everything is in operational condition.
19. Clean up site.

To take down the tent, reverse the preceding installation steps.

Guy Rope Installation

